

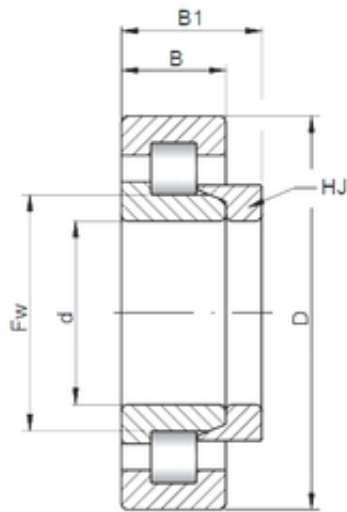

NEI Manufacturing Bearing LTD.



85 mm x 180 mm x 41 mm ISO NH317
cylindrical roller bearings

Bearing No. NH317

Size	85x180x41 mm
Bore Diameter	85 mm
Outer Diameter	180 mm
Width	41 mm
d	85 mm
D	180 mm
B	41 mm
C	41 mm
B1	12 mm
B2	18,5 mm

NH317 Bearing 2D drawings and 3D CAD models